

Robertshaw®

41-400N Series

SILICON NITRIDE IGNITORS

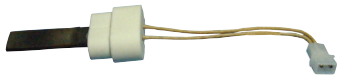

41-401N



41-407N



41-402N

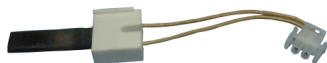

41-408N



41-403N

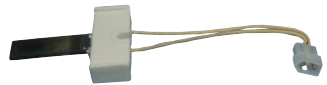

41-409N

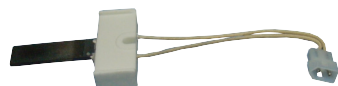

41-404N

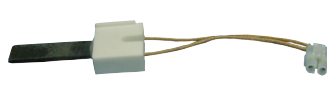

41-410N

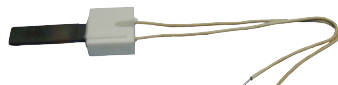

41-405N

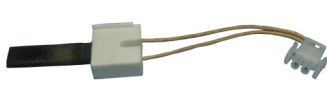

41-411N

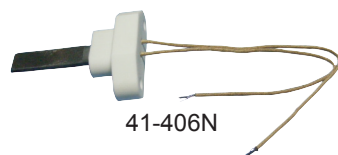

41-406N

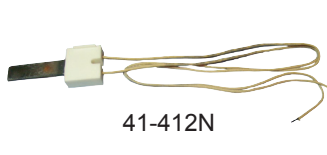

41-412N

Features and Benefits

The Robertshaw® Silicon Nitride Hot Surface Ignitors provide a new and resilient solution to gas ignition. The Silicon Nitride Ignitor provides exceptional improvement in durability by virtually eliminating breakage.

- All Robertshaw Silicon Nitride Hot Surface Ignitors are very durable, robust and resistant to rust, dirt, condensation, oils or falling debris from the heating element.
- The Robertshaw Silicon Nitride Ignitors are 120V AC. Some hot surface modules are rated for 208/240 volts input, however they step the voltage to the ignitor down to 120V AC.
- High temperature leads are enclosed with a special fiberglass insulation providing superior electrical protection.
- This ignitor is a functional upgrade or replacement to Silicon Carbide applications.
- Ignitors are boxed with mounting hardware and termination required for direct replacement.

Robertshaw - *Simply the Right Choice™*

An ISO 9001 – 2008 Certified Company

2 Year
Limited
Warranty

Technical Specifications

⚠ ATTENTION: Flame sensors are required for all Silicon Nitride Igniters. Ignitor/Sensor assembly 1751-729 (24" lead) or 1751-749 (72" lead) can be used if an existing flame sensor is not present and a terminal is available on the ignition control.

Uni-Line® Part Number	Ceramic Block Style	Terminal Block Style	Lead Wire Length	Comments
41-401N	A	A	5-1/4"	Includes a gasket
41-402N	B	None	24"	
41-403N	C	None	5-1/4"	
41-404N	C	D	5-3/4"	Includes special mounting
41-405N	D	None	9"	
41-406N	E	None	9"	Includes a gasket
41-407N	C	B	5-3/4"	
41-408N	B	C	5-3/4"	
41-409N	C	D	5-3/4"	
41-410N	B	B	5-3/4"	
41-411N	B	C	5-3/4"	Includes special mounting
41-412N	F	None	24"	

CERAMIC BLOCK STYLES

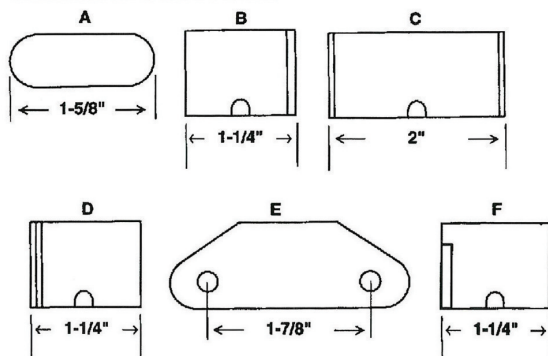

TERMINAL BLOCK STYLES

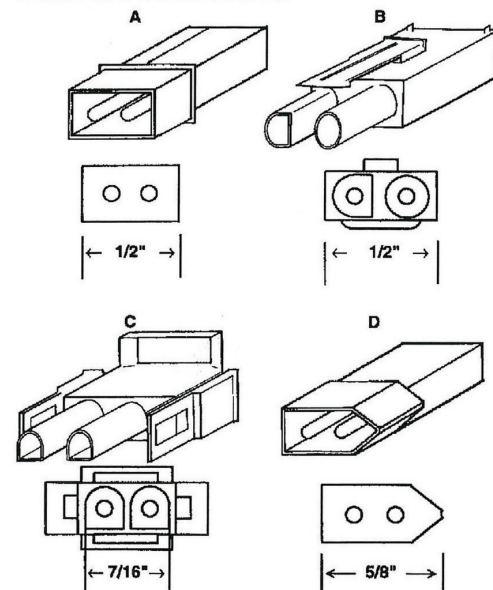



41-400N Series

SILICON NITRIDE IGNITORS

Robertshaw 41-400N Series Ignitor Cross Reference

OEM	OEM Part No.	Uni-Line® Part No.
Amana	10041601	41-401N
	B1336102	41-401N
	D99182	41-401N
	10755002	41-402N
	B138196P01	41-403N
	B144676P02	41-407N
	B340039P01	41-408N
	B144676P01	41-410N
American Appliance	271B	41-406N
American Standard	IGN0030	41-403N
American Water Heater	6905032	41-402N
	6901800	41-406N
	6903767	41-406N
	6903768	41-406N
Arco Aire	100-9980	41-402N
Armstrong	38322B001	41-402N
Barnett Brass	661923	41-401N
	661924	41-403N
	661925	41-406N
	661926	41-407N
	661927	41-409N
	661928	41-411N
Carrier	LH33ZS001A	41-409N
	LH33ZS002	41-409N
	LH33ZS003	41-409N
	LH33ZS004	41-409N
Claire Brothers	C-238	41-402N
	C-242	41-402N
Coleman / Evcon	1474-051	41-402N
	1474-052	41-402N
Comfort Zone	1501140401	41-406N
	150114-04-01	41-406N
GMO Industries	20834	41-402N
Duncane Heating Corp.	20015201	41-409N
Enerco	10399	41-402N
Ez Flow	62374	41-412N
Frigidaire	6320770	41-402N
	6320880	41-402N
	632-3540	41-402N
	RH622286893	41-402N
GE / Hotpoint	WG37X11	41-403N
	WG37X34	41-403N
Gemline	IG-106	41-406N
	IG-107	41-412N
Glow Core	1950001	41-406N
	FY 009	41-406N
	HSRK7	41-406N
Goodman Mfg.	B11726-06	41-402N
	B1401009	41-412N
Grimsby Stove	ZCO-350	41-402N
GSW	71082	41-412N
	86483	41-412N
HB Smith	9050	41-402N
	101344	41-405N

OEM	OEM Part No.	Uni-Line® Part No.
HB Smith (continued)	1148245	41-405N
	50018	41-405N
Heatmaker	2400-048	41-401N
	2400-286	41-401N
	2600-359	41-401N
	3079-100	41-401N
	9330-102	41-401N
Heil Quaker	1001344	41-405N
	1148145	41-405N
	1009604	41-412N
	1096048	41-412N
Intercity	1009604	41-412N
Integra	3260618	41-402N
	6905032	41-402N
International Comfort Products	1096047	41-412N
Johnstone Supply	L37-698	41-401N
	L37-699	41-402N
	L37-700	41-403N
	L37-812	41-405N
	L37-813	41-406N
	L37-814	41-407N
	L37-815	41-408N
	L37-816	41-409N
Lennox Industries	96P01	41-401N
	36N77	41-403N
	98P77	41-405N
	98P78	41-408N
Lochinvar Corp.	LCVT27021G	41-406N
	PLT2702	41-406N
Majestic	75-92-104	41-402N
	75-92-105	41-402N
Mor-Flo Industries	3200618	41-402N
	3200580	41-406N
	3210401	41-406N
Nordyne	105141000	41-402N
	632-0770	41-402N
	632-0880	41-402N
Norton	201A	41-401N
	271A	41-401N
	201K	41-402N
	201L	41-402N
	201N	41-402N
	201P	41-402N
	201R	41-402N
	201W	41-402N
	271N	41-402N
	271W	41-402N
	201	41-403N
	271	41-403N
	271M	41-403N
	271M	41-404N
	201D	41-405N
271D	41-405N	



41-400N Series

SILICON NITRIDE IGNITORS

Robertshaw 41-400N Series Ignitor Cross Reference (continued)

OEM	OEM Part No.	Uni-Line® Part No.
Norton (continued)	271P	41-405N
	201B	41-406N
	201J	41-406N
	201M	41-406N
	201Y	41-406N
	271Y	41-406N
	271M	41-407N
	271N	41-408N
	271	41-409N
	271N	41-410N
	271N	41-411N
	271NM	41-412N
Olsen Ind.	26789	41-402N
Perfection Schwank	108803-G1	41-406N
Raytheon	D9918202A	41-401N
Raypak Inc.	50015	41-403N
	600915	41-403N
Rheem	62-22441-01	41-402N
	62-22441-01	41-408N
	62-22668-93	41-408N
	90434300	41-409N
	62-22868-82	41-411N
Roberts Gordon Appl.	90436600	41-402N
Robertshaw	41-401	41-401N
	41-402	41-402N
	41-403	41-403N
	41-404	41-404N
	41-405	41-405N
	41-406	41-406N
	41-407	41-407N
	41-408	41-408N
	41-409	41-409N
	41-410	41-410N
	41-411	41-411N
	41-412	41-412N
Snyder General	1380654	41-403N
	1380672	41-409N
	1380680	41-409N
Starlite	11120-100-1401	41-401N
	11120-100-1402	41-402N
	11120-100-1403	41-403N
	11120-100-1405	41-404N
	11120-100-1406	41-406N
	11120-100-1407	41-407N
	11120-100-1408	41-408N
	11120-100-1409	41-409N

OEM	OEM Part No.	Uni-Line® Part No.
Supco	SIG-401	41-401N
	SIG-402	41-402N
	SIG-403	41-403N
	SIG-405	41-405N
	SIG-106	41-406N
	SIG-406	41-406N
	SIG-407	41-407N
	SIG-408	41-408N
	SIG-409	41-409N
	SIG-410	41-410N
	SIG-108	41-411N
	SIG-107	41-412N
	SIG-412	41-412N
	Superior Fireplace	94851
Temp Controls	9302-094	41-405N
Trane	340039P01	41-402N
	340039P1	41-402N
	IGN21	41-402N
	IGN23	41-402N
	201	41-403N
	IGN26	41-403N
	IGN30	41-403N
	IGN30	41-407N
	IGN-0034	41-408N
IGN34	41-408N	
Trianco Heatmaker	2600-359	41-401N
Wayne Home Equip	62821-001	41-402N
	62821-002	41-402N
Weil Mclane	79074	41-402N
	511-330-193	41-403N
	511-330-190	41-404N
	511-330-188	41-406N
	511-330-139	41-409N
Whirlpool	99794323	41-402N
	99794326	41-406N
	99794328	41-408N
White LB Co.	120-07549	41-402N
White-Rodgers	767A-309	41-401N
	767A-352	41-401N
	767A-356	41-401N
	767A-357	41-402N
	767A-361	41-405N
York International	025-32625-000	41-402N
	025-27766-000	41-405N
	025-27774-000	41-405N
	025-29043-000	41-405N
	025-29050-000	41-405N

inven'sys
Controls

191 E. North Avenue
Carol Stream Illinois 60188 USA
Customer Service Telephone 1.800.304.6563
Customer Service Facsimile 1.800.426.0804
HVACCustomerService@InvensysControls.com

For Technical Service
Telephone 1.800.445.8299
Facsimile 1.630.260.7294
TechnicalService@InvensysControls.com

Invensys™, Robertshaw®, Uni-Line® and Simply the Right Choice™ are trademarks of Invensys plc., its subsidiaries and/or affiliated companies. All other brands mentioned may be the trademarks of their respective owners.

www.Uni-Line.com
www.InvensysControls.com
©2009 Invensys Controls 10/09 - 150-2171B