

- 8.- To install the replacement gasket, start at the corners. The hard lower lip section of the gasket will slide under the inner panel. (See Figure 12.)

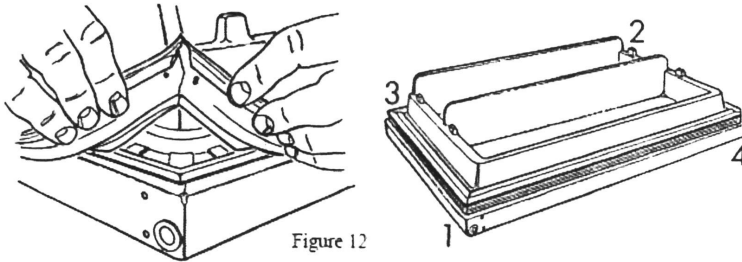

Figure 12

- 9.- Using your finger, snap the gasket into place. (See Figure 13 & 14.) If a small part of the gasket should be hard to get under the edge of the inner panel, use a small edge roller* or similar tool to push the gasket into place.

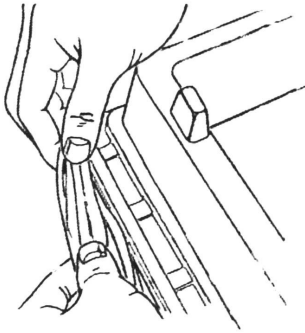

Figure 13

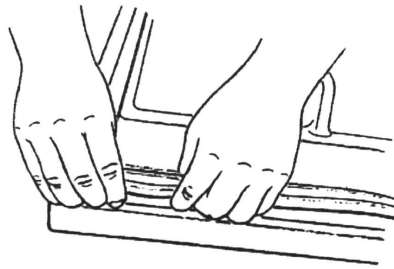

Figure 14

- 10.- After installing gasket, rehang the door on the refrigerator (See figure 15)
The gap between the door and the cabinet (bottom, top and side) should be around the diameter of a dime. Check the gap in several places.

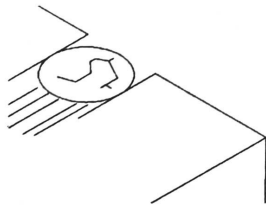

Figure 15

Door Gasket replacement



BEFORE STARTING

- 1.-Check to see if you have the correct size of gasket before starting repair
- 2.-Take door of refrigerator and place it on top of a table:
3. Start from the middle of one of the longer sides by lifting the edge of the gasket carefully (See Figures 2 & 3.)

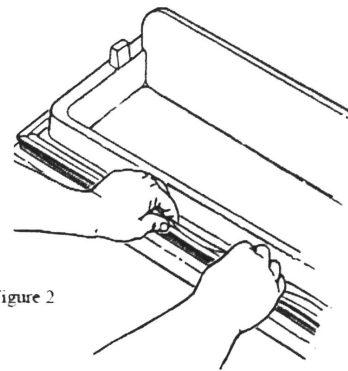

Figure 2

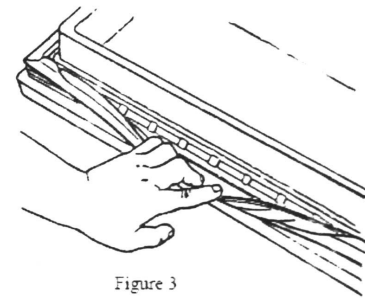

Figure 3

4. After lifting the edge of the gasket, use a pair of wire cutters to cut the gasket. (See Figures 4 & 5)

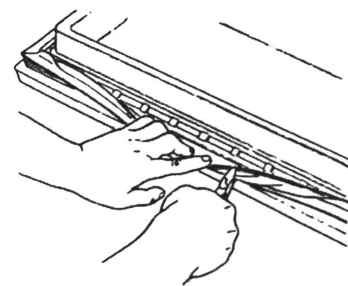

Figure 4

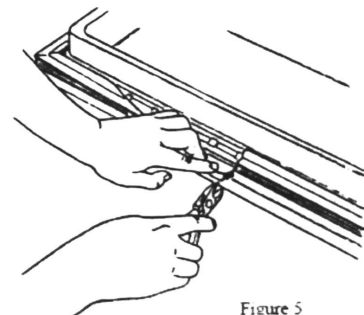
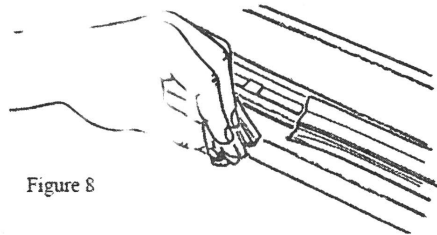
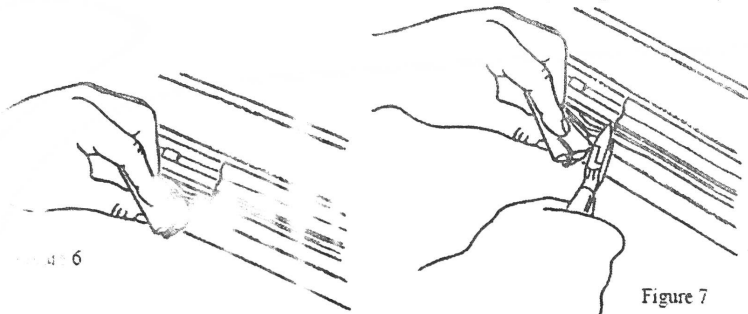
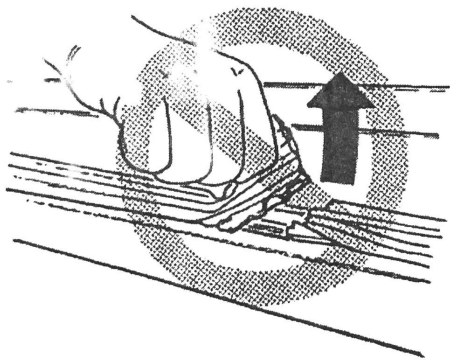

Figure 5

5. Pull the gasket out laterally and use the second part of the gasket. (See Figures 6, 7 & 8.)



NOTE: DO NOT PULL UP ON THE GASKET. This action will pull the interior door away from the exterior door. (See Figure 10.)



6. To remove the gasket, pull it away laterally from the door. (See Figure 9.)

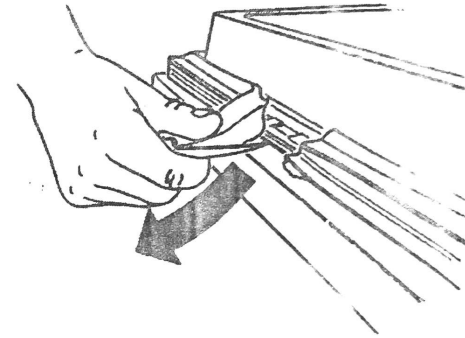

7. After the gasket has been removed, check to see if there is any debris around the edges. (See Figure 11.) If there is, use a knife to clean it up. Do not go in more than $\frac{1}{4}$ " under the edge of the panel.

